



CONTENTS

● Lesson Flowchart	4
● Map	6
● Meet the Kibbits	8

UNIT 1 My Family and Friends

Lesson 1	My Brothers and I	10
Lesson 2	My Mom and Dad	14
Lesson 3	My Best Friend	18
Lesson 4	My Pet	22

UNIT 2 My Places

Lesson 1	My Room	28
Lesson 2	Our Living Room	32
Lesson 3	My Classroom	36
Lesson 4	The Playground	40

UNIT 3 Our Town

Lesson 1	Our Neighborhood	46
Lesson 2	Our Town	50
Lesson 3	Neighborhood Stores	54
Lesson 4	Adventures of J & J: - Under the Bed -	58

MY FIRST WRITING IS A FUN AND EASY WRITING SERIES FOR GRADE 1, BEGINNERS. IT IS DESIGNED TO HELP STUDENTS DEVELOP SENTENCE-BUILDING SKILLS FROM THE START. WITH THE HELP OF THE CHARACTERS IN THE SERIES, STUDENTS WILL LEARN TO WRITE SENTENCES STEP BY STEP.



MY FIRST WRITING 1

UNIT 4 My Favorites

Lesson 1	My Favorite Character	64
Lesson 2	My Favorite Toy	68
Lesson 3	My Favorite Animal	72
Lesson 4	My Favorite Place	76

UNIT 5 Activities

Lesson 1	My Day	82
Lesson 2	My Dad's Day	86
Lesson 3	After School Activities	90
Lesson 4	Weekend Activities	94

UNIT 6 School Fun

Lesson 1	School Fun	100
Lesson 2	A Talent Show	104
Lesson 3	A School Field Trip	108
Lesson 4	Adventures of J & J: - The Lake Monster -	112

● Scope and Sequence	118
----------------------	-----



UNIT 1

My Family and Friends

LESSON 1 My Brothers and I



LESSON 2 My Mom and Dad



LESSON 3 My Best Friend



LESSON 4 My Pet



MY FIRST WRITING 1



- Unit 1 My Family and Friends
- Unit 2 My Places
- Unit 3 Our Town
- Unit 4 My Favorites
- Unit 5 Activities
- Unit 6 School Fun



LESSON 1

My Brothers and I

1 Warm Up

A. Choose and circle. Complete the story.



My Brothers and I

My name is Ella Kibbits.

I am (a girl / a boy).

I am 8 years old.

I am (tall / pretty).

Finn and Cody (am / are) my brothers.

Finn is 9 years old.

Cody is 10 years old.

They are (funny / sad).

B. Write the name.



2 Word Practice

A. Choose and complete the sentence.

sisters a boy a girl my brother my sister

1 I am a girl .



2 I am _____ .



3 We are _____ .



4 He is _____ .





5 She is _____ .





B. Look and write the word.

happy tall short funny sad smart

1  He is funny .

2  They are _____ .

3  She is _____ .

4  They are _____ .

5  She is _____ .

6  He is _____ .

3 Grammar Practice

A. Circle the number and say the sentences. Discuss your choices.

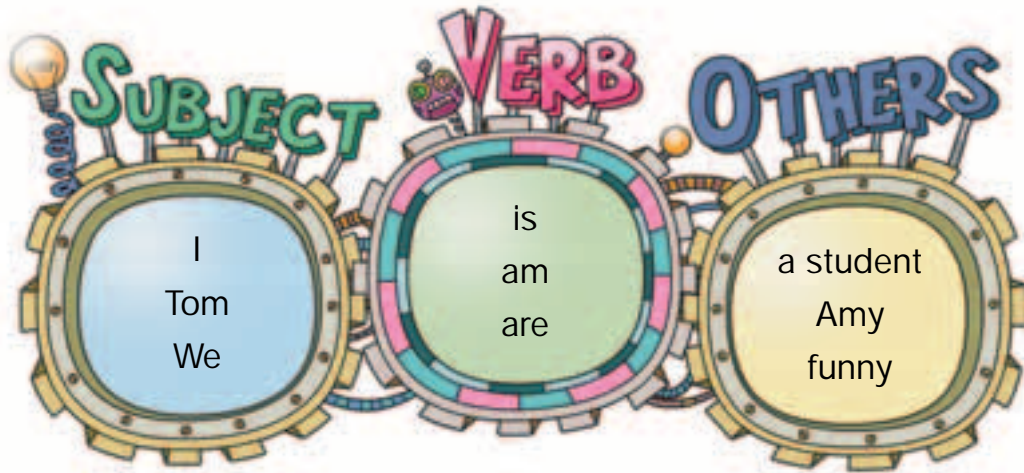

- 1 I can make (1 2 **3**) sentence(s) with "I."
- 2 I can make (1 2 3) sentence(s) with "Tom."
- 3 I can make (1 2 3) sentence(s) with "We."

Total Number
of Sentences

B. Write **am**, **is** or **are**.

- 1 I _____ a boy.
- 2 My name _____ Mike.
- 3 Jake and Tim _____ my brothers.
- 4 They _____ smart.
- 5 She _____ a student.
- 6 He _____ 9 years old.
- 7 You _____ funny.
- 8 Luke _____ tall.



4 Writing Practice

A. Look and write.



His _____ is Sam.

He is _____ years old.

He is _____.

B. Look and write the sentence using the correct Be-verb.

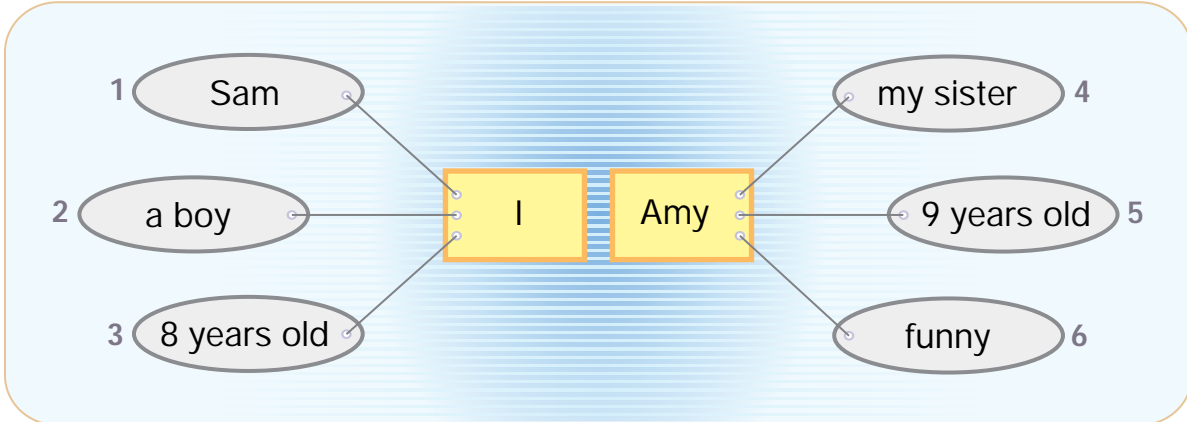

1 _____	4 Amy _____
2 _____	5 She _____
3 _____	6 _____

C. Write your story.

Go to pages 4 and 5 in your workbook. Draw and write your story.

LESSON 2

My Mom and Dad

1 Warm Up

A. Write **He** or **She**. Complete the story.

My Mom and Dad

My mom is a doctor.
 Her name is Asta Kibbits.
 _____ is kind.
 _____ is 38 years old.

My dad is an inventor.
 His name is Todd Kibbits.
 _____ is smart.
 _____ is 39 years old.



B. Check **True** or **False**.

- | | | |
|-------------------------------|--|---|
| 1 Ella's mom is 38 years old. | <input checked="" type="checkbox"/> True | <input type="checkbox"/> False |
| 2 Ella's dad is a toy maker. | <input type="checkbox"/> True | <input checked="" type="checkbox"/> False |
| 3 Ella's dad is smart. | <input type="checkbox"/> True | <input checked="" type="checkbox"/> False |

2 Word Practice

>> Go to page 16. Play the game.

3 Grammar Practice

A. Write the sentence correctly.

This is my friend.

We are best friends.

• Each sentence begins with a capital letter. (T, W)

• Each sentence ends with a period. (.)

1 my name is Mary

2 he is my brother

3 this is my mother

4 she is busy

B. Circle the correct word(s).

1 My sister is a student / students .

2 My mother is 38 year old / 38 years old .

3 She is kind / a kind .

4 My dad is truck driver / a truck driver .

5 He is strong / a strong .

6 We are a student / students .



Play with a partner. Roll the die. Circle the picture and write the word.

Student A

Choose any.

Word Bank

- a businessman
- a doctor
- a homemaker
- a nurse
- a teacher



He is _____.



She is _____.



He is _____.

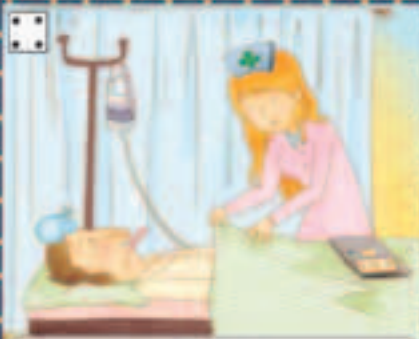

She is _____.



He is _____.

Student B

Choose any.

Word Bank

- young
- strong
- old
- kind
- busy



She is _____.



She is _____.



She is _____.



He is _____.



She is _____.

4 Writing Practice

A. Write the words in the correct order.

- 1 brother / My / a / is / student / . _____
- 2 funny / is / He / . _____
- 3 nurse / is / My / mom / a / . _____
- 4 are / They / happy / . _____

B. Look and write the sentence using the correct Be-verb.

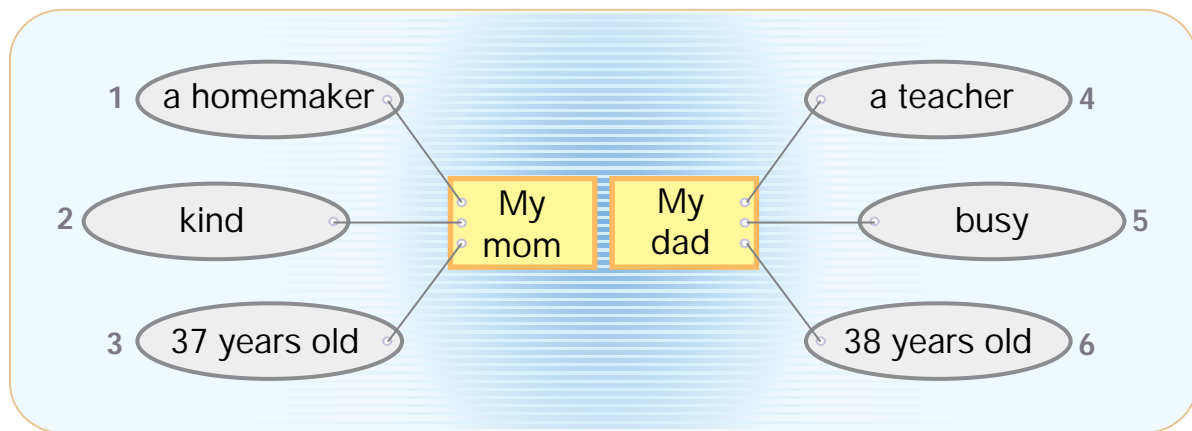

- | | |
|-------------------|---------------|
| 1 My mom
_____ | 4
_____ |
| 2 She
_____ | 5 He
_____ |
| 3
_____ | 6
_____ |

C. Write your story.

Go to pages 6 and 7 in your workbook. Draw and write your story.

LESSON 3 My Best Friend

1 Warm Up

A. Choose and write the sentences. Complete the story.

- She is small.
- She is funny too.
- This is Poly.

My friend Poly

She is my best friend.

She is 8 years old.

Poly is not big.

She is clever.

She is friendly.

Ella~



B. Write Yes or No.

1 Is Poly Ella's friend? _____

2 Is Poly a boy? _____

3 Is Poly big? _____

4 Is Poly friendly? _____

2 Word Practice

A. Choose and complete the sentence.

my best friend best friends my teacher teachers

1 We are _____.



2 We are _____.



3 He is _____.



4 She is _____.



B. Look and write the word. Discuss your choices.

big clever friendly funny happy young

1 She is happy.



2 They are _____.



3 It is _____.



4 They are _____.



5 He is _____.



6 She is _____.



3 Grammar Practice

A. Write This or That.

1  _____ is my dad.

2  _____ is my mom.

3  _____ is my sister.

4  _____ is my brother.

B. Write the sentence correctly.

This is Tom. Tom and Mary are my friends.	• Each name begins with a capital letter.
--	---

- 1 My name is amy. _____
- 2 ken is my friend. _____
- 3 My best friend is sam. _____
- 4 This is scott. _____
- 5 max is my dog. _____

4 Writing Practice

A. Circle the correct word(s).

- 1 This is Amy. She / He is my friend.
- 2 Amy and I am / are best friends.
- 3 Ted is smart / a smart .
- 4 They are a student / students .



B. Look and write the sentence using the correct Be-verb.

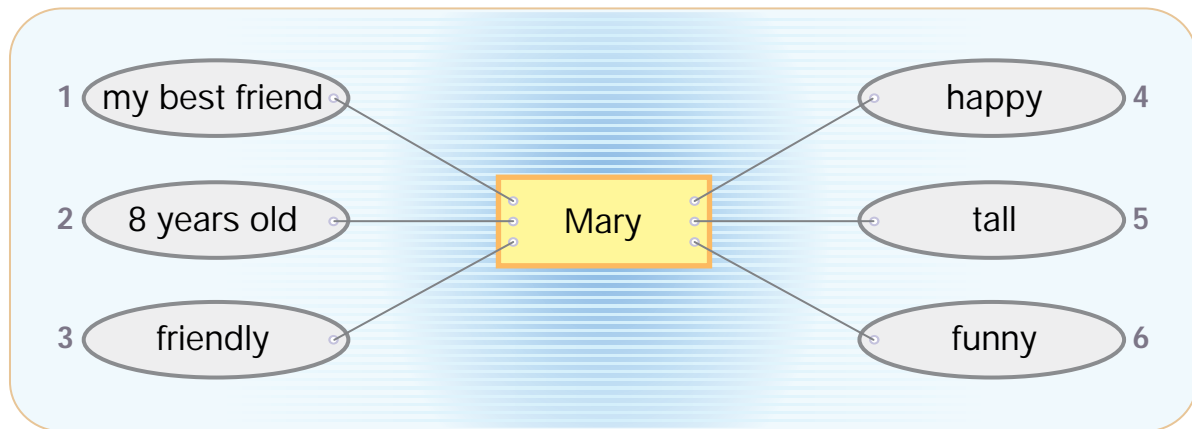

- | | |
|--------------|---------|
| 1 Mary _____ | 4 _____ |
| 2 She _____ | 5 _____ |
| 3 _____ | 6 _____ |

C. Write your story.

Go to pages 8 and 9 in your workbook. Draw and write your story.

LESSON 4 My Pet

1 Warm Up

A. Choose and write the words.
Complete the story.

short big is are

My Pet Mr. T

This is my pet.

His name _____ Mr. T.

Mr. T is cute.

His eyes are _____.

His nose is yellow and round.

His legs _____ strong.

His tail is _____.

Mr. T is happy.



B. Read and match.

1 His eyes are... ○

○ ...big.

2 His nose is... ○

○ ...strong.

3 His legs are... ○

○ ...round.

2 Word Practice

A. Look and write the word.

cat	hamster	iguana	rabbit	turtle
back	eyes	skin	nose	tail

1



This is my _____.

Her name is Kitty.

Her _____ is long.

2



This is my _____.

His name is Iggy.

His _____ is green.

3

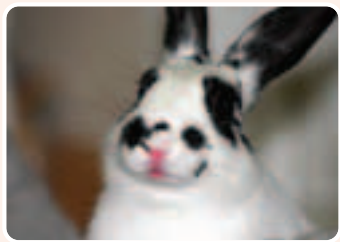

This is my _____.

Her name is Bunny.

Her _____ is pink.

4



This is my _____.

Her name is Star.

Her _____ are small.

5

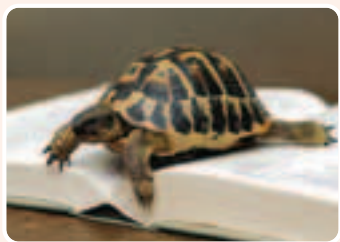

This is my _____.

His name is Mr. Cool.

His _____ is hard.

3 Grammar Practice

A. Look and circle the correct word.

ex1 This is Amy.
Her hair is long.

ex2 That is John.
His hair is short.

ex3 That is a rabbit.
Its eyes are red.

1 

His / Her / Its shirt is wet.

2 

His / Her / Its dress is long.

3 

His / Her / Its beak is hard.

4 

His / Her / Its tail is short.

5 

His / Her / Its color is yellow.

B. Write are or is.

- 1 Her legs _____ long.
- 2 His name _____ Robo.
- 3 His eyes _____ cute.
- 4 Its hair _____ brown.
- 5 Her hands _____ small.



4 Writing Practice

A. Write the words in the correct order.

- 1 Kitty / Her / is / name / . _____
- 2 His / pretty / eyes / are / . _____
- 3 long / is / tail / Its / . _____
- 4 color / Its / brown / is / . _____

B. Look and write the sentence using the correct Be-verb.

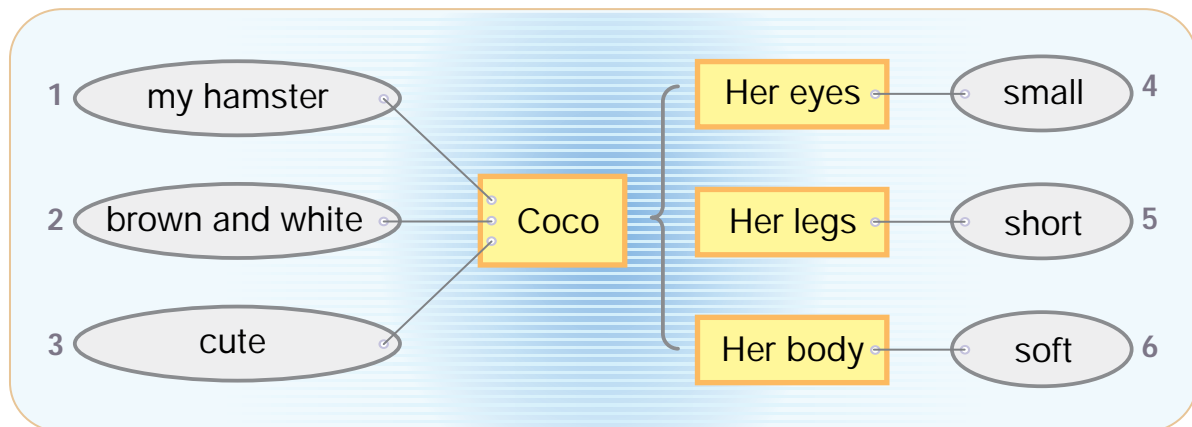

- | | |
|--------------|---------|
| 1 Coco _____ | 4 _____ |
| 2 She _____ | 5 _____ |
| 3 _____ | 6 _____ |

C. Write your story.

Go to pages 10 and 11 in your workbook. Draw and write your story.



Fun Writing Project



➤➤ Make your family poster.

- **Step 1** Prepare a sheet of colored construction paper.
- **Step 2** Glue your family photo in the center.
- **Step 3** Write about your family members.

My Lovely Family

created by Cindy Larson

This is my sister.
Her name is Alice.
She is 13. She is tall.

This is my mom.
Her name is Debbie Larson.
She is 40 years old.
She is a teacher.

This is my brother.
His name is Jacob.
He is 6. He is very smart.

This is my dad.
His name is Tom Larson.
He is 42 years old.
He is a school bus driver.

I'm Cindy Larson.
I'm 8 years old.
I'm small and cute.

This is our talking dog.
His name is Pac.
He is small and white.