

UNIT **1**

Nice to Meet You!

  1. Look and trace.



Lesson 1: Unit Introduction

Words: door, desk, teacher, book

WORDS

  1. Look and trace.  2. Color.

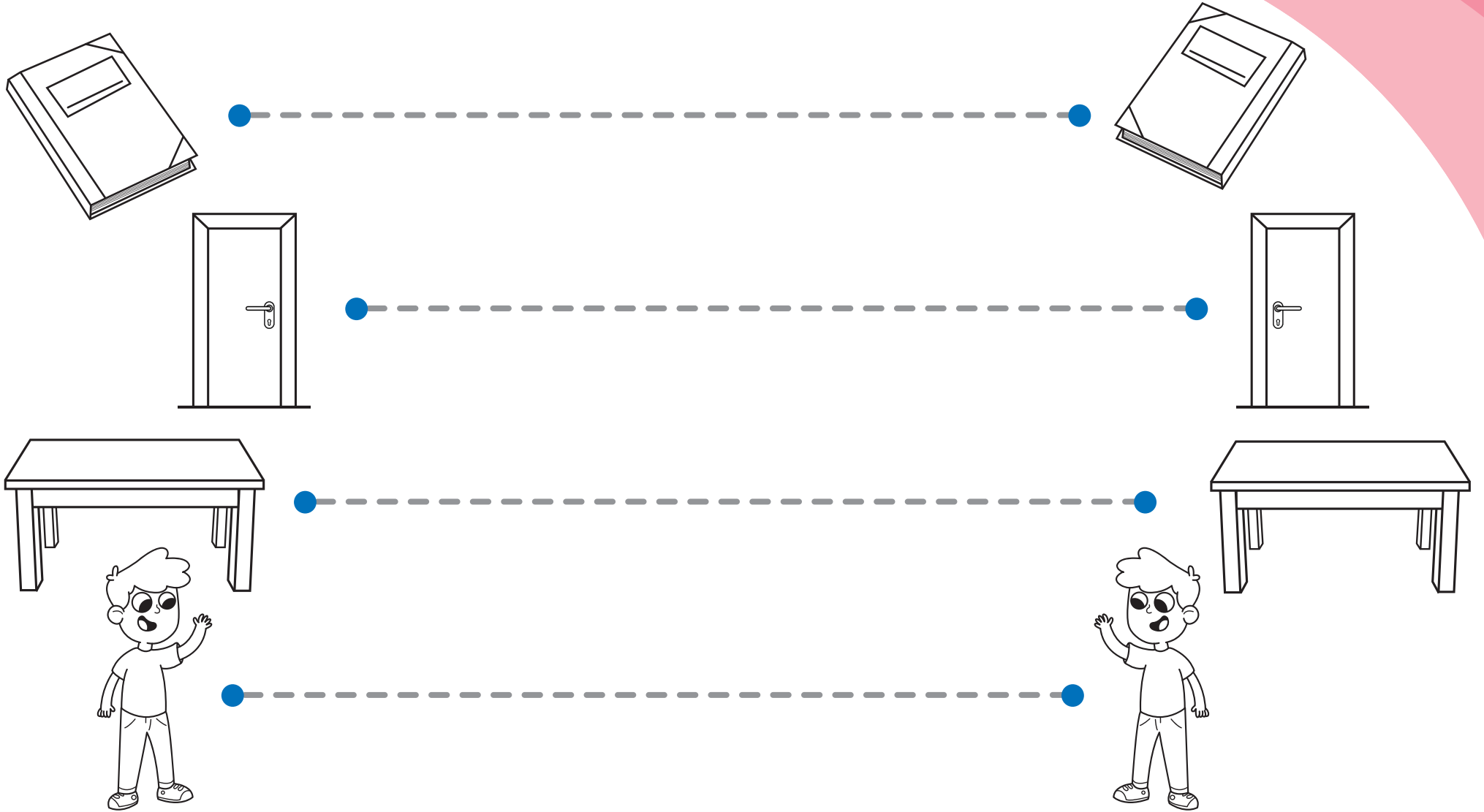

Lesson 2: Vocabulary Presentation
Words: *book, door, desk, teacher*

SENTENCES

My Name Is Ana

1. Trace. 2. Look, cut, and glue the correct images.



Lesson 3: Grammar Presentation

Words: hello, Tony, Lulu, Ana, Bonnie, Harry

Sentences: Hello, my name is Ana. Nice to meet you.



1. Look and color.

My Classroom

1



2



3



4



Lesson 4: Story

Words: book, desk, teacher, apple, thank you

Sentences: Hello, my name is Tony. This is my teacher.

VALUES

Greetings

  1. Look and color the correct face.



 2. Color the pictures.

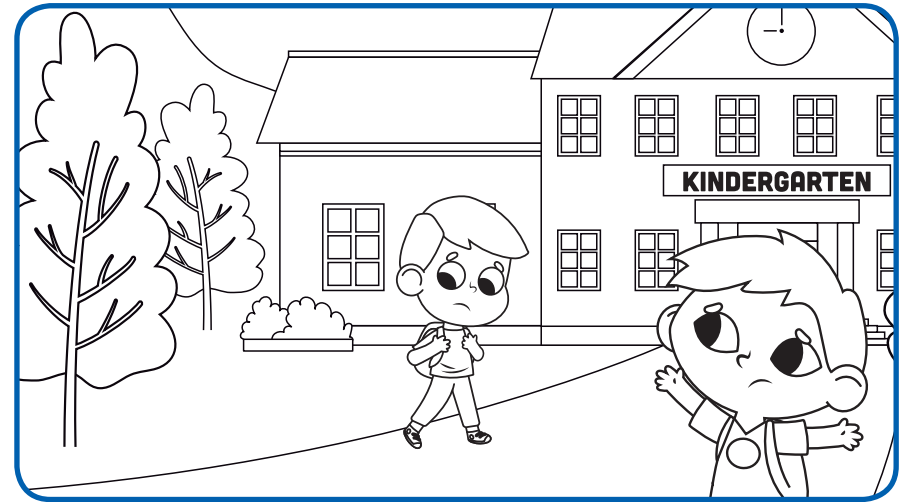

PHONICS

Aa, Bb, Cc

  1. Look and trace.

 2. Color.

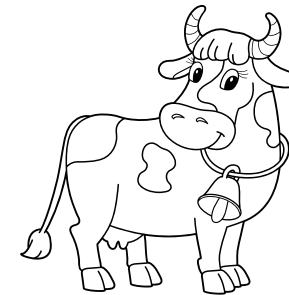
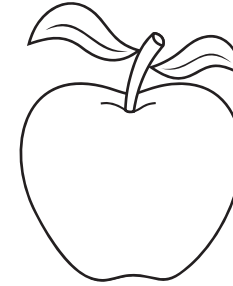
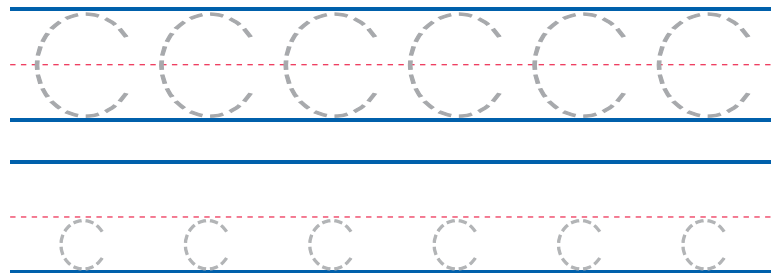
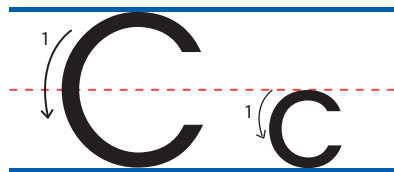
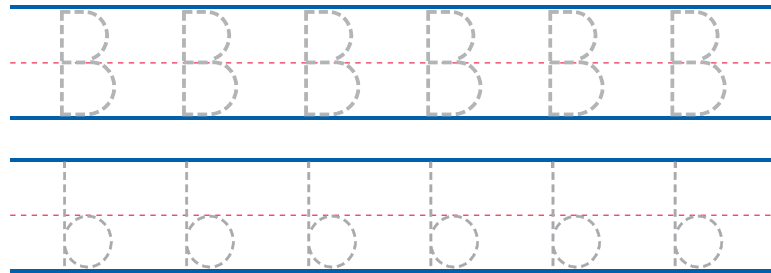
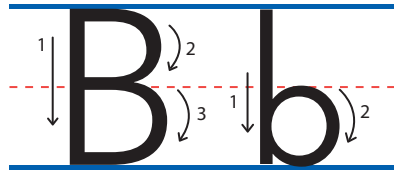
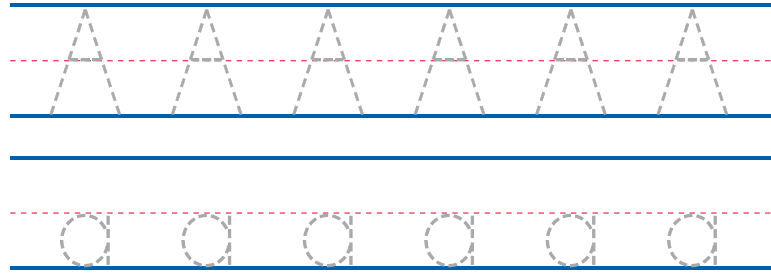
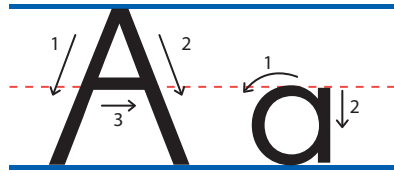



1. Count and trace.



2. Color.

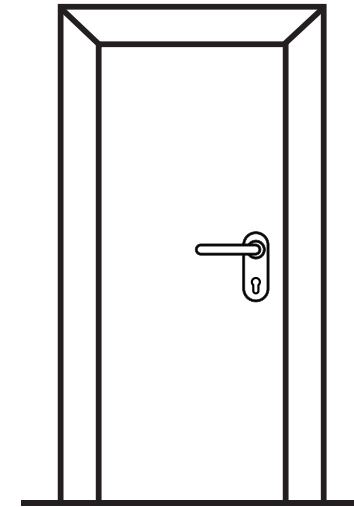
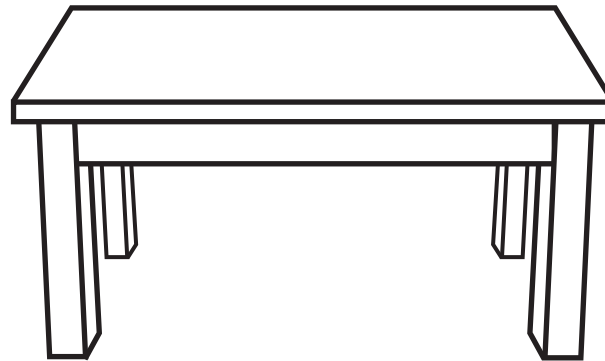
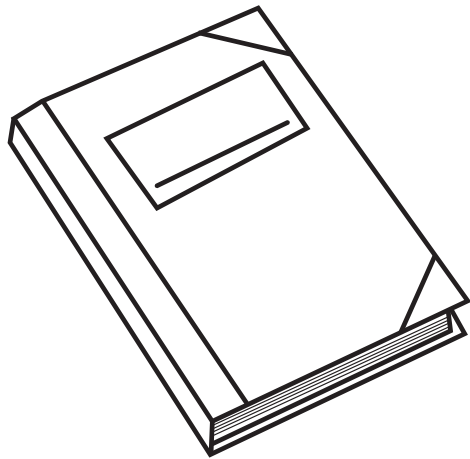

SOCIAL STUDIES

Say Hello!

  1. Look and color.

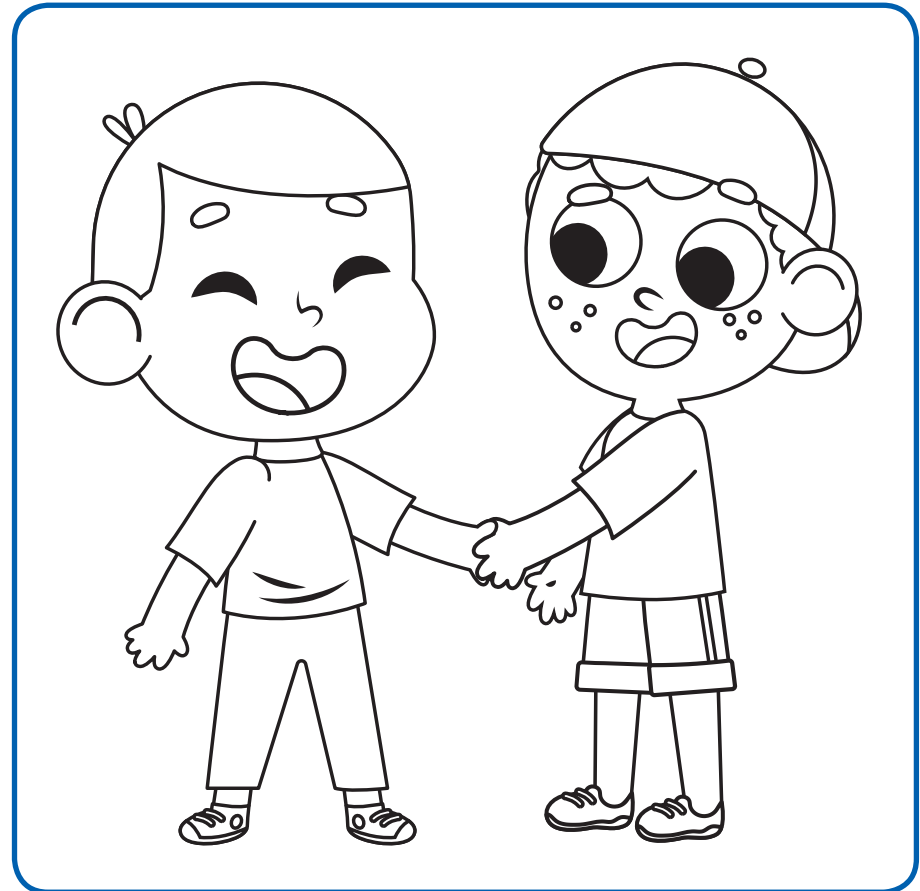
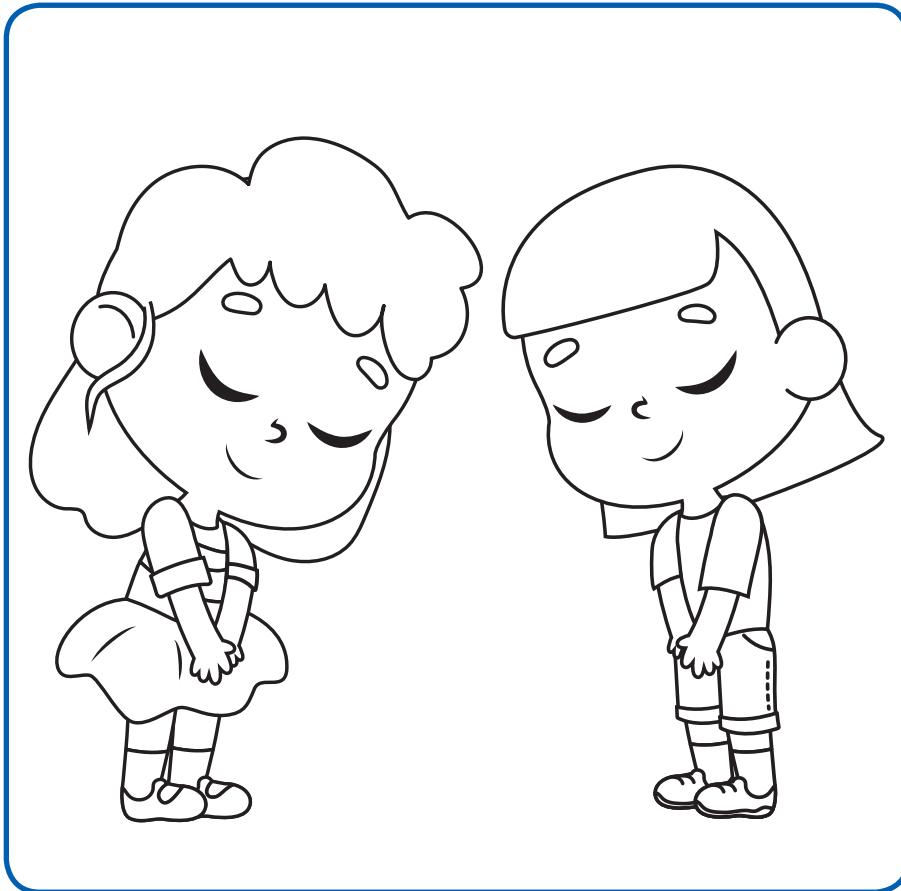

PROJECT **Waving Hand**

-  1. Color the hand.  2. Trace and color your own hand.

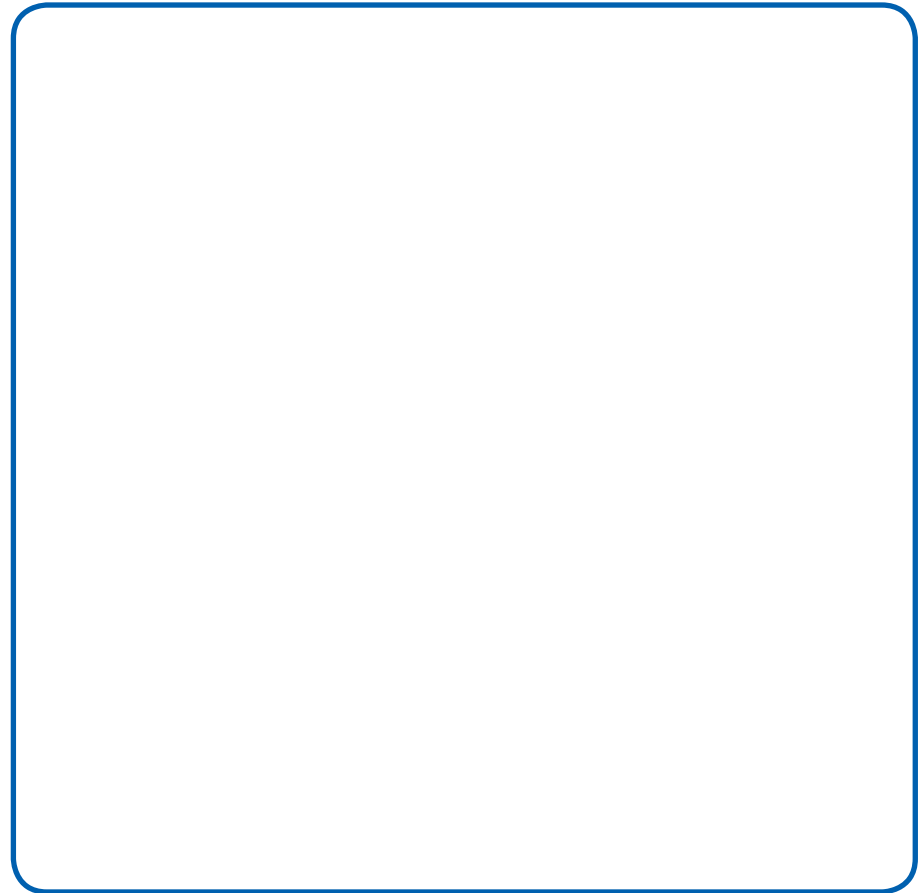
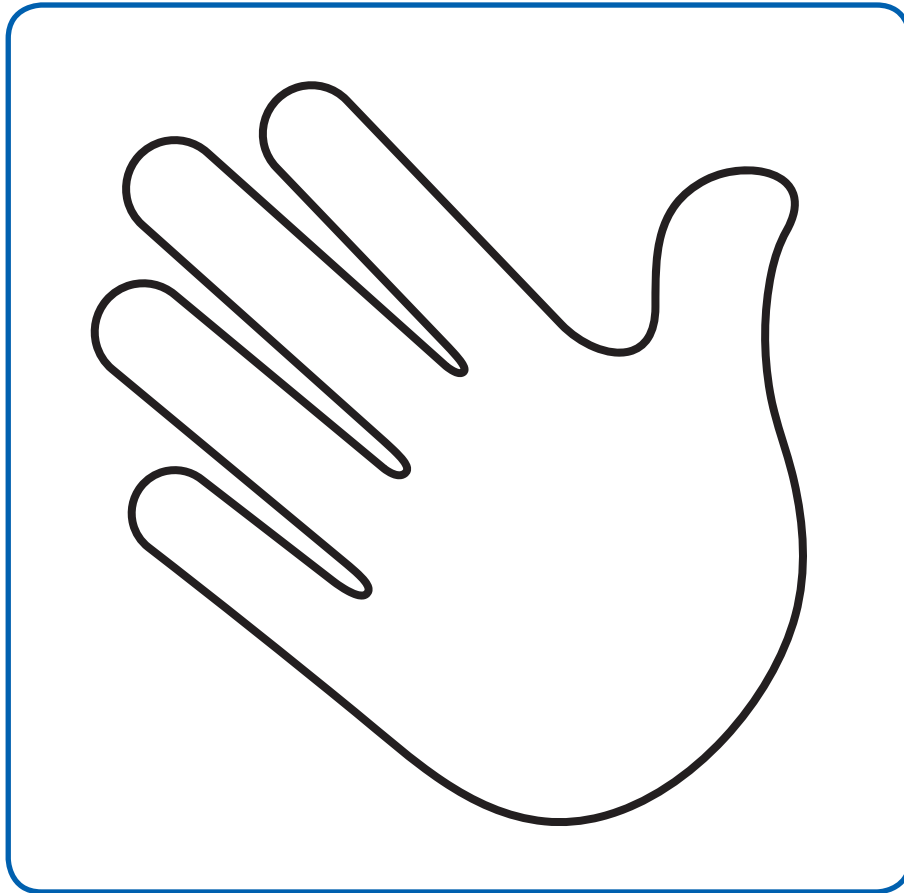

REVIEW



1. Look and color.

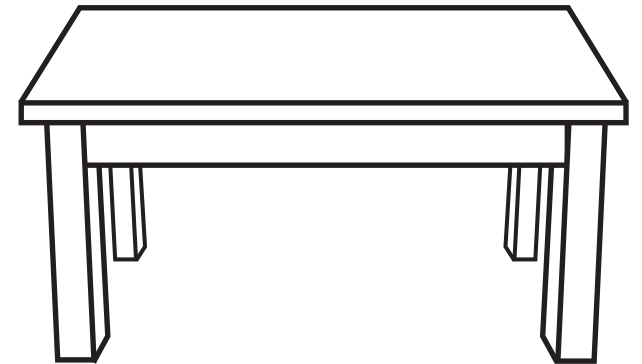
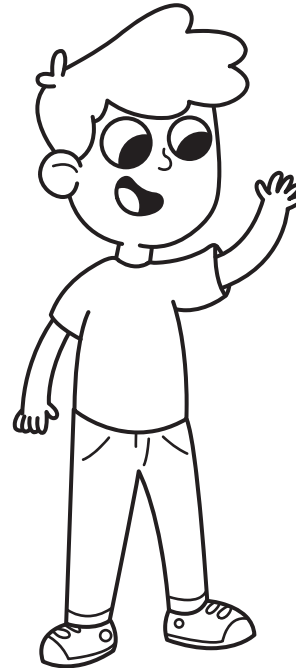
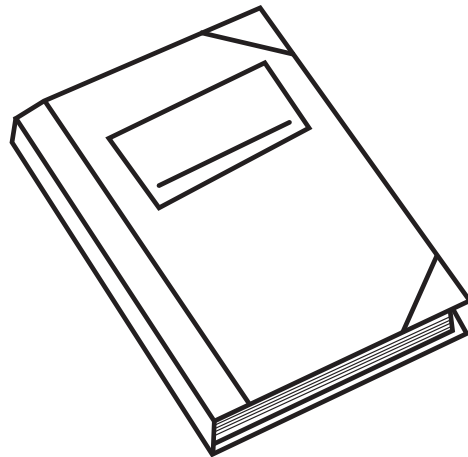
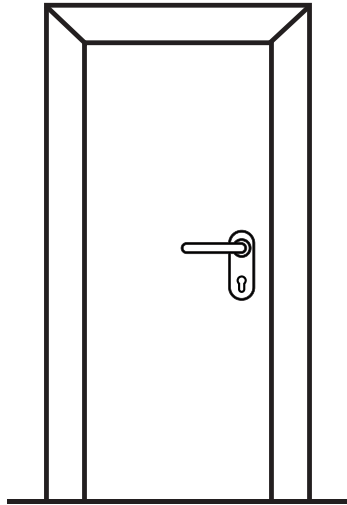

Lesson 10: Review

Words: door, book, teacher, desk

Sentences: Hello! My name is Lulu. Nice to meet you.
This is a desk.